



Notice de montage

Assembly manual





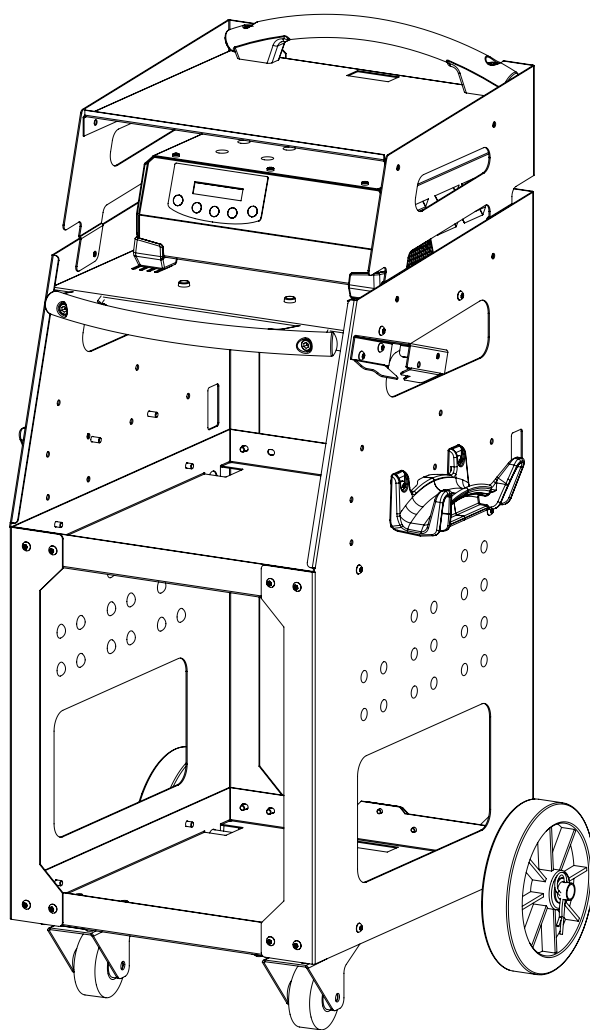







Montageanleitungen

CHARIOT / TROLLEY / FAHRWAGEN
GYSFLASH



**CHARIOT / TROLLEY / FAHRWAGEN
GYSFLASH**



Tableau récapitulatif / Summary table / Zusammenfassende Tabelle

	Dimensions	Quantity	Reference
	M5 x 10	x 3	41053
	M6 x 10	x 38	41288
	M6 x 20	x 4	41026
	M8 x 12	x 8	41281
	M8 x 40	x 4	42066
	M8 x 20	x 2	41244
	M5	x 3	41154
	M6	x 42	41151
	M8	x 14	41157
	-	x 2	43125
	-	x 2	43170
	-	x 2	42032
OPTION 	-	x1	025745

Outils / Tools / Werkzeug







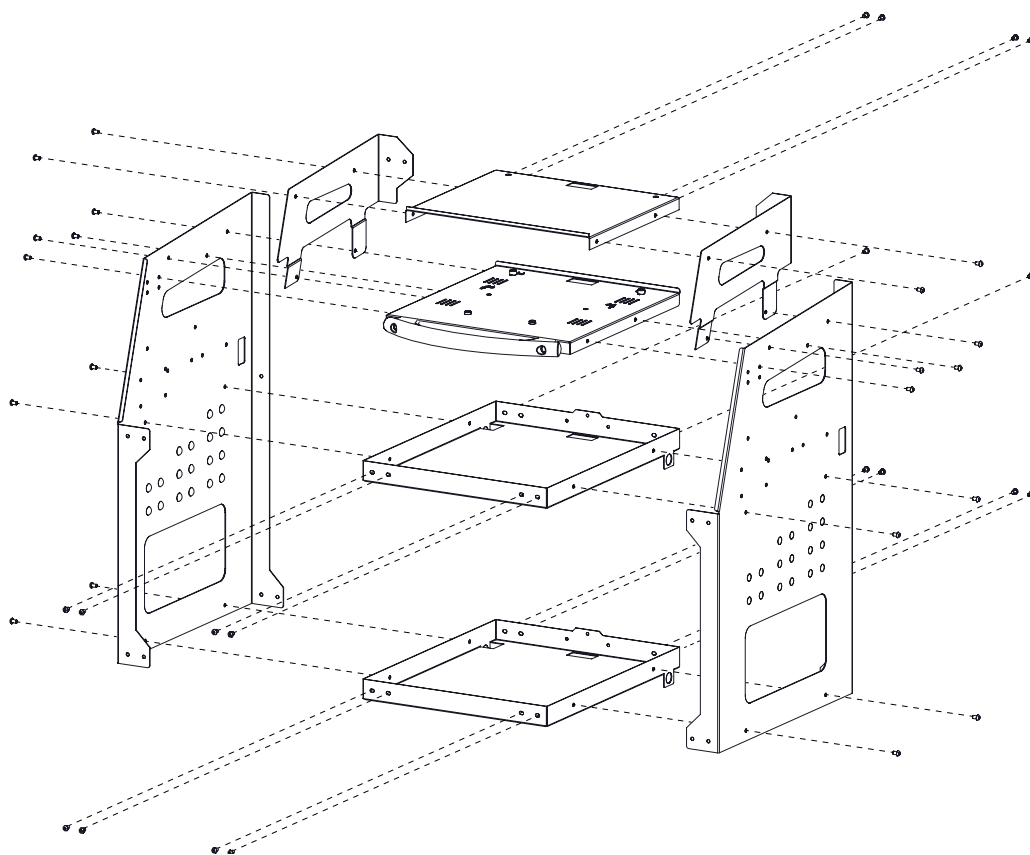

CHARIOT / TROLLEY / FAHRWAGEN GYSFLASH

1 |  x38 : M6 x 10  x38 : M6



 20 N·m

2 |  x8 : M8 x 12  x8 : M6  x3 : M5 x 10  x3 : M5  x 2  x 2

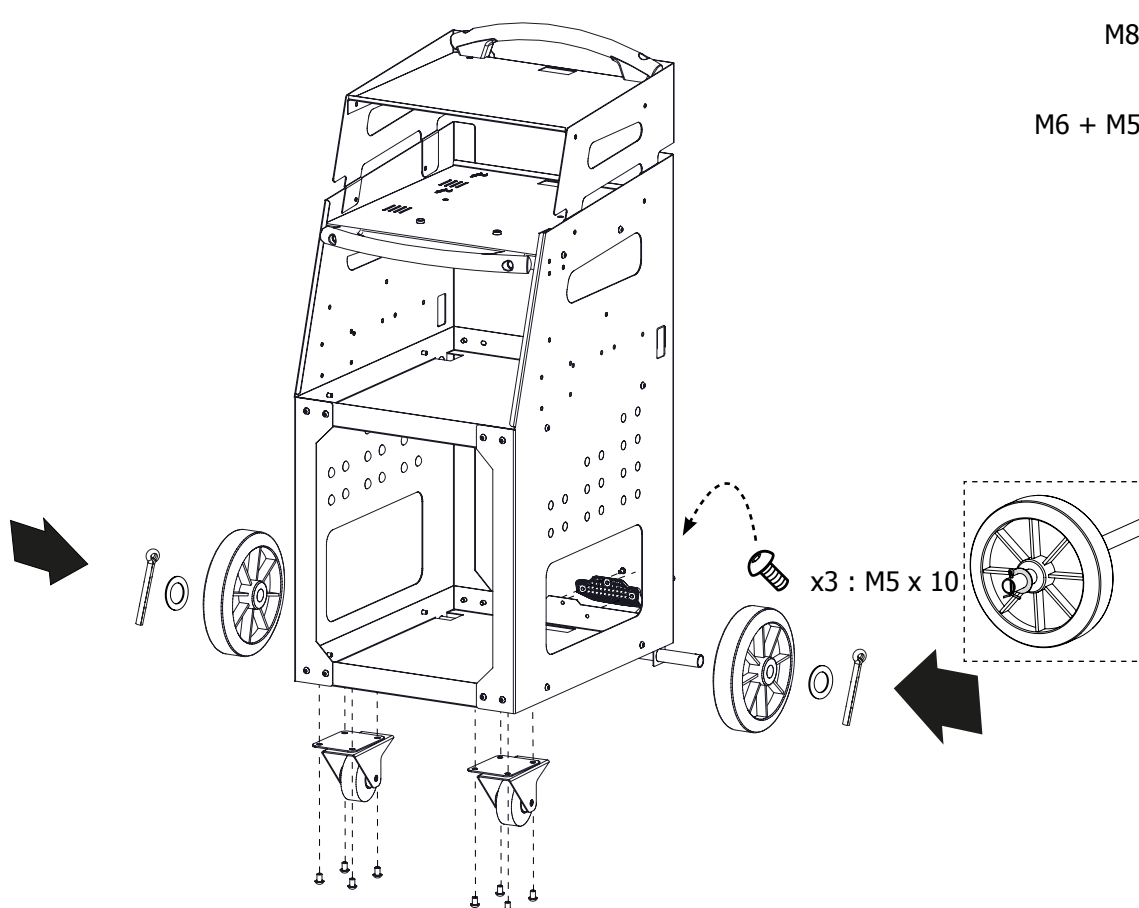





M8 |  20 N·m



M6 + M5 |  8 N·m

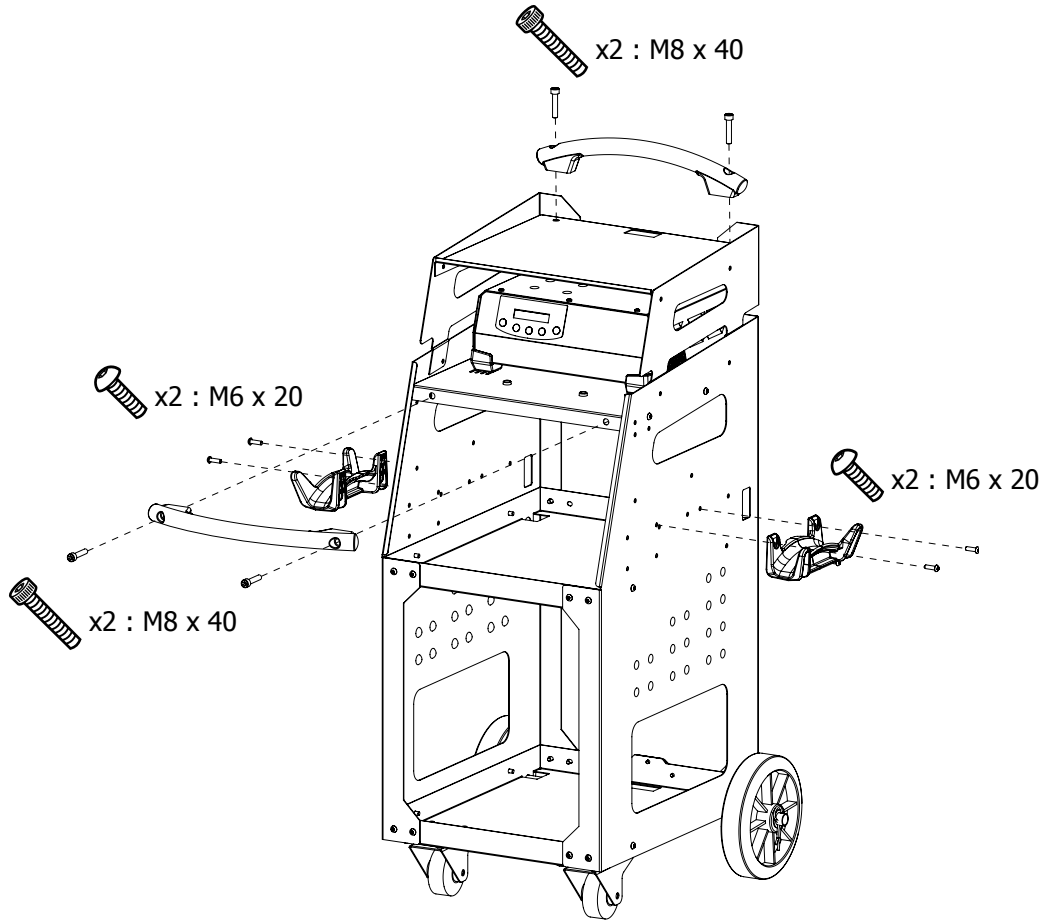

x3 : M5 x 10

CHARIOT / TROLLEY / FAHRWAGEN GYSFLASH

3 |  x4 : M6 x 20  x4 : M6  x4 : M8 x 40  x4 : M8



M8 |  20 N·m
M6 |  8 N·m



4 |  x2 : M8 x 20  x2 : M8  x2

: Gysflash 30 A | - : Gysflash 40 & 50 A | + : Gysflash 100 A | = : Gysflash 121.12 CNT

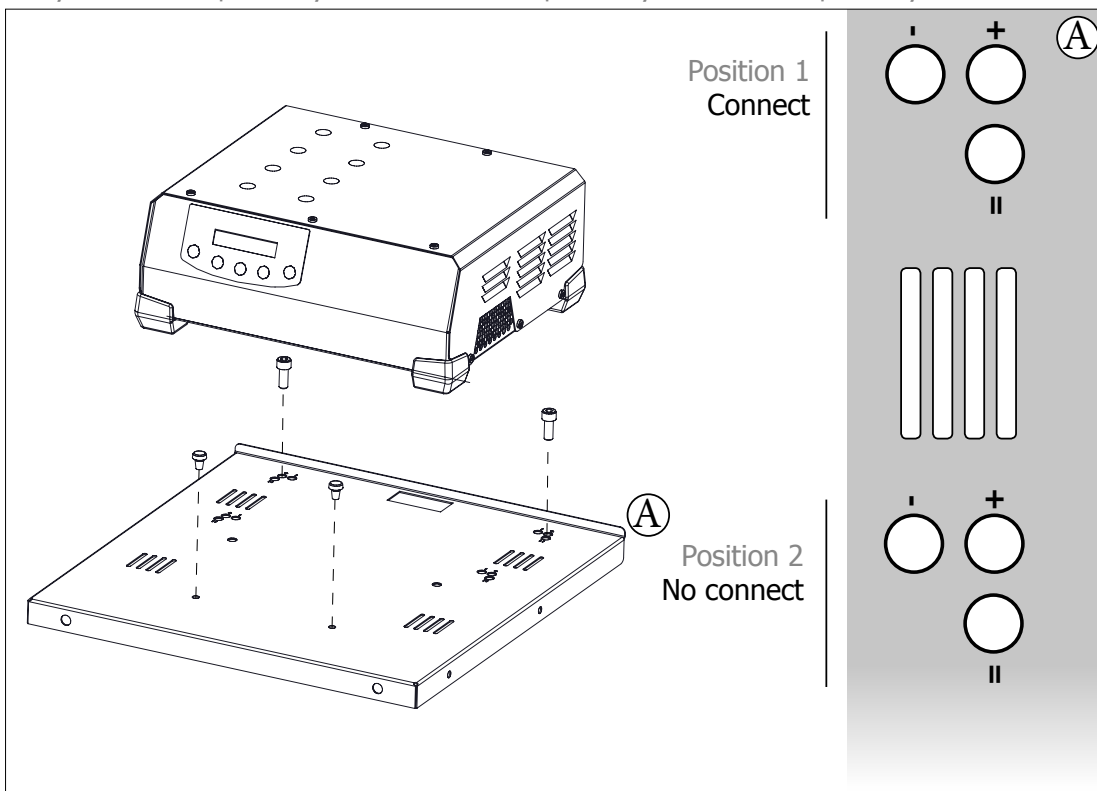
M8 |  20 N·m



**CHARIOT / TROLLEY / FAHRWAGEN
GYSFLASH**

5 | OPTION (025745) |  x2 : M6 x 20  x2 : M6  x1

M6  8 N·m

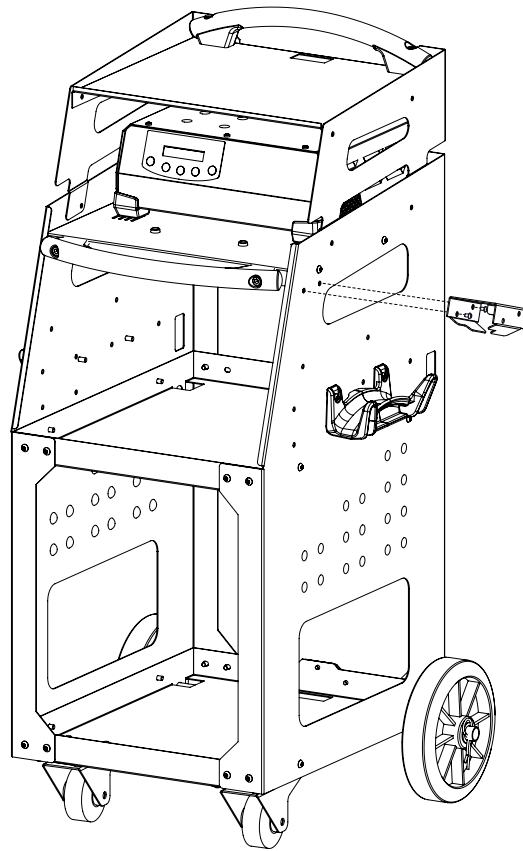

6 |

