

Power Probe IV

Users Manual



POWER PROBE®

The Next Generation of Diagnostics

www.powerprobe.com · 800-655-3585

Table of Contents

| | |
|---|-------|
| Introduction | 2 |
| Safety | 3 |
| Appearance and Controls | 4-5 |
| Start Up | 6 |
| Mode Navigation | 7 |
| Testing and Measuring Operations | |
| • DC Voltage in VDC Mode | 8 |
| • Activating Components | 9 |
| • Power Feed Test | 10-11 |
| • AC Voltage Measurement (RMS) | 12 |
| • AC Voltage Measurement (P to P) | 13 |
| • Frequency Measurement | 14 |
| Advanced Testing Operations | |
| • PPECT Mode | 15 |
| • Fuel Injector Mode | 16-17 |
| • Driver Test Mode | 18-19 |
| Tool Repair Operations | 20-21 |
| Specifications | 22 |
| Notes | 23-24 |
| Warranty | 25 |

Power Probe IV

Introduction



Thank you for purchasing the Power Probe IV Diagnostic Electronic Circuit and Component tester. The Power Probe IV is the next generation of Power Probe Circuit Testers. Now loaded with powerful multi-meter functions, advanced diagnostic test modes, an easy to read color LCD display and a new rugged water and dust resistant housing, the Power Probe IV is designed to give you years of trouble free testing, even in the most demanding work environments.

The unique configuration of Power Probe testers gives them many advantages over using conventional test lights or multi-meters for circuit testing.

(1) Since the Power Probe IV is connected to the battery, you can apply battery power or battery ground directly to the tip of the tool. You can energize and activate components to verify their correct operation. This is real dynamic component testing and the only true way to test an active component.

(2) The Power Probe IV is always connected to the vehicle's battery, so the tool maintains a permanent connection to the source power and ground voltage. Circuit voltage checks are quickly performed with just a single probe connection, unlike using two meter leads.

(3) Using the PPIV, all your voltage checks are referenced back to the source battery and account for every connection and possible voltage drop between the source and the probe tip.

(4) Automatic Voltage Drop Indication - When probing a circuit, if the voltage measured at the tip is 0.5 volts lower (or more) than the source battery voltage, the red LED will not illuminate and no speaker tone will sound. This will instantly alert you that there is a voltage drop that may need to be investigated or repaired.

CAUTION - PLEASE READ

To avoid possible electric shock or personal injury and to avoid damage to the Power Probe or item being tested, please use the Power Probe according to the following safety procedures:

- Power Probe recommends reading this manual before using the Power Probe IV.
- This product is designed to be powered from DC power sources such as found in Automotive, Small Craft Marine and Small Craft Aviation electrical systems and will be damaged if connected to line voltage such as 115V AC power sources or 24V AC Control circuits.
- Do not connect to electrical system with higher than rated voltage specified in this manual.
- Do not test voltage exceeding the rated voltage on the Power Probe IV.
- When testing voltage exceeding 30V AC RMS, 42V AC Peak, or 60V DC, be particularly careful to avoid any electric shock.
- Check the Probe IV case for cracks or damage. Damage to the case can leak high voltage causing a potential electrocution risk.
- Check the Probe IV cables for any insulation damage or bare wires. If damaged, do not use the tool, please contact Power Probe Technical support.
- Use only shrouded leads and accessories authorized by Power Probe to minimize exposed conductive electrical connections to eliminate shock hazard.
- Do not open the Power Probe IV, no serviceable parts are inside. Opening the Power Probe IV voids the warranty. All repairs should only be performed by authorized Power Probe service centers.
- When maintaining the Power Probe, use only replacement parts specified by the manufacturer.
- Use only in well ventilated areas. Do not operate around flammable materials, vapor or dust.
- Be careful when energizing components that have moving parts, assemblies containing motors or high powered solenoids.
- Power Probe, Inc. shall not be liable for damage to vehicles or components caused by misuse.
- Power Probe, Inc. shall not be held liable for any harm caused by unintentional or intentional misuse of our products or tools.
- If you have any questions please go to our website www.powerprobe.com or contact Power Probe's Technical Support: 800-655-3585.

Appearance and Controls

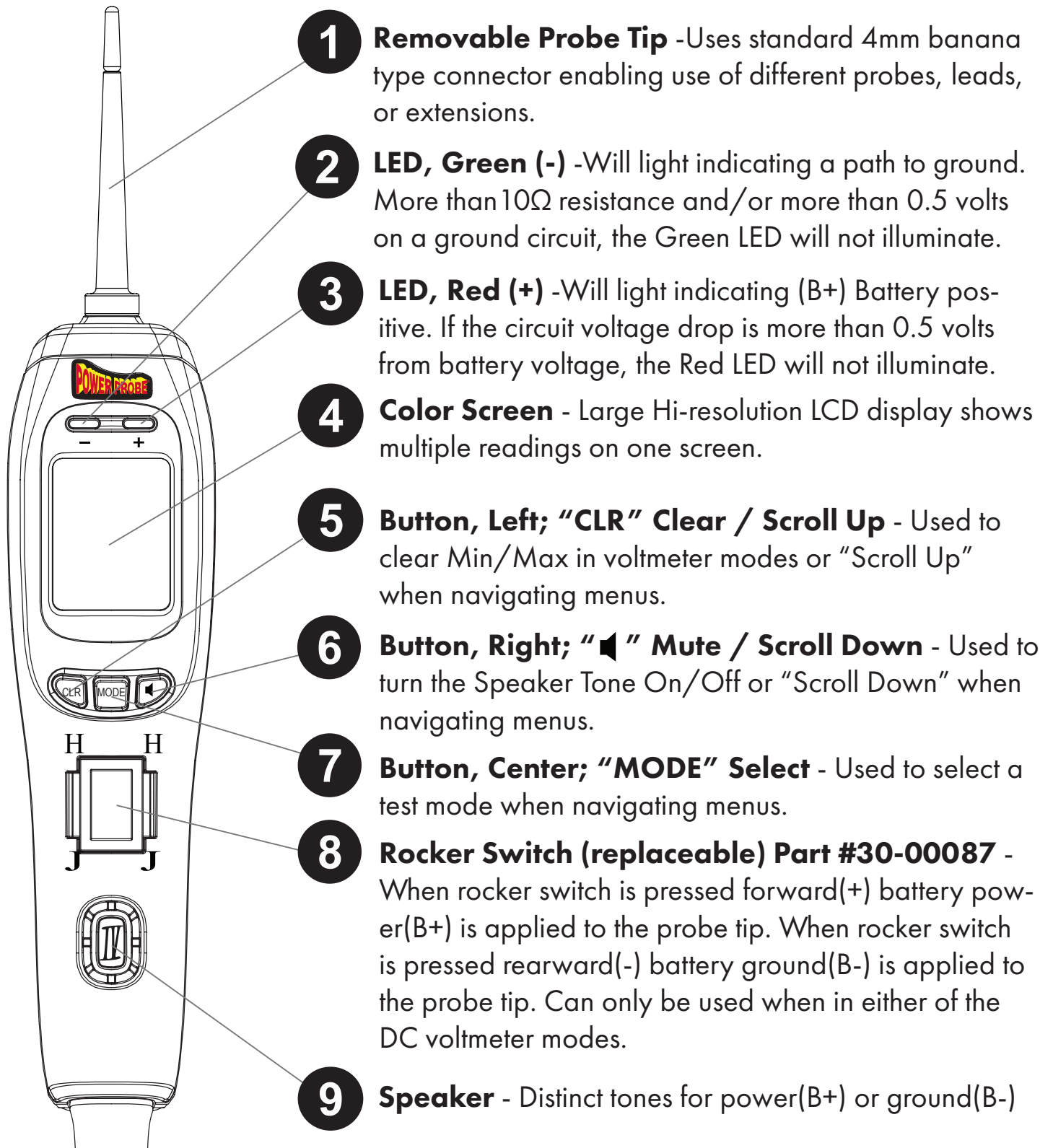

1 Removable Probe Tip -Uses standard 4mm banana type connector enabling use of different probes, leads, or extensions.

2 LED, Green (-) -Will light indicating a path to ground. More than 10Ω resistance and/or more than 0.5 volts on a ground circuit, the Green LED will not illuminate.

3 LED, Red (+) -Will light indicating (B+) Battery positive. If the circuit voltage drop is more than 0.5 volts from battery voltage, the Red LED will not illuminate.

4 Color Screen - Large Hi-resolution LCD display shows multiple readings on one screen.

5 Button, Left; "CLR" Clear / Scroll Up - Used to clear Min/Max in voltmeter modes or "Scroll Up" when navigating menus.

6 Button, Right; "Mute" Mute / Scroll Down - Used to turn the Speaker Tone On/Off or "Scroll Down" when navigating menus.

7 Button, Center; "MODE" Select - Used to select a test mode when navigating menus.

8 Rocker Switch (replaceable) Part #30-00087 - When rocker switch is pressed forward(+) battery power(B+) is applied to the probe tip. When rocker switch is pressed rearward(-) battery ground(B-) is applied to the probe tip. Can only be used when in either of the DC voltmeter modes.

9 Speaker - Distinct tones for power(B+) or ground(B-)

Appearance and Controls

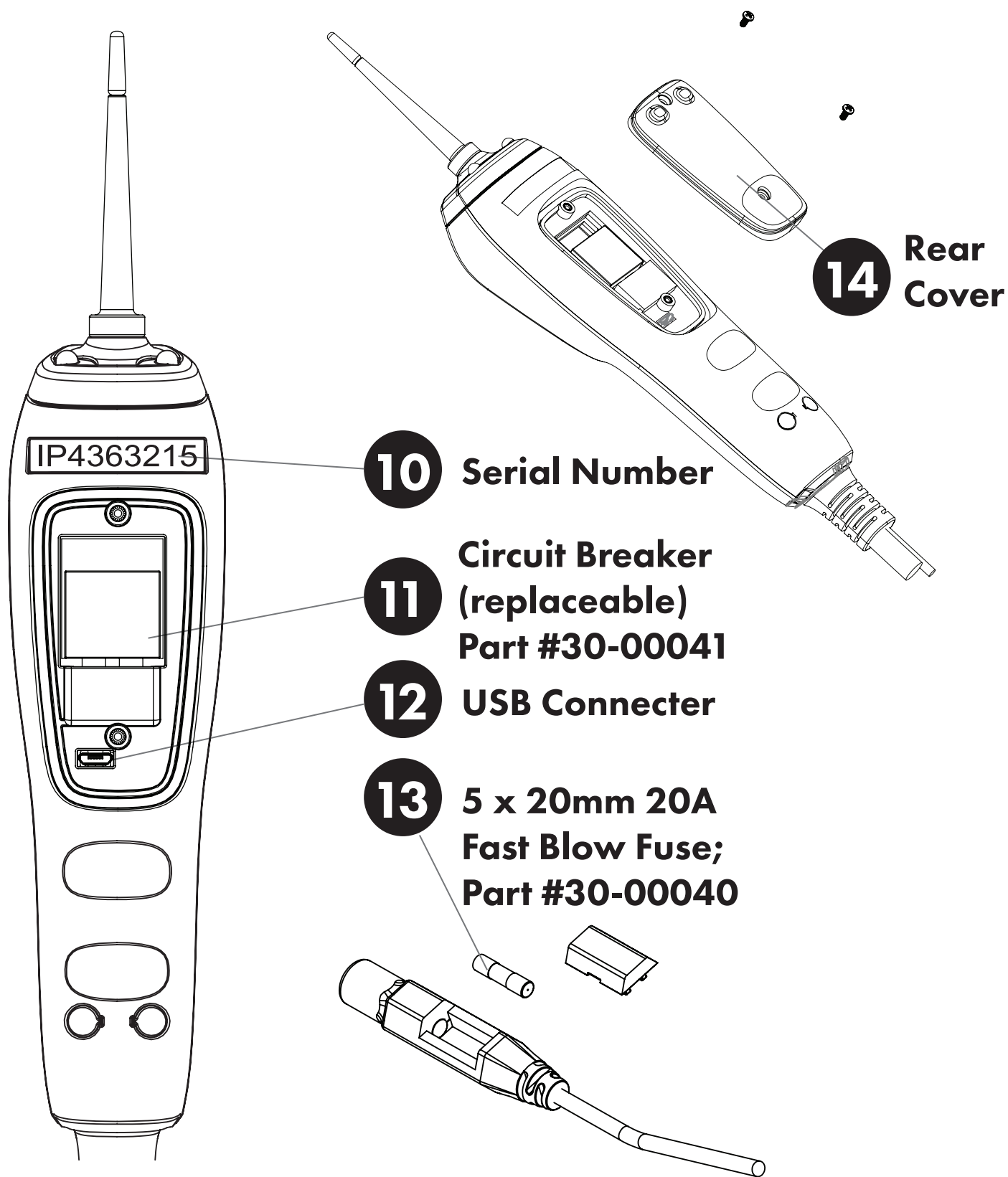

Power Probe IV

Start-Up

Operating Source Voltage

The Power Probe IV is designed to connect to and is powered by 12 to 24 VDC electrical systems and comes supplied with a 23 ft., heavy duty power cable and a Y-connector with 2 battery clips.

Connecting to the Vehicle's Battery (Voltage Source)

Connect the red clip to the positive terminal of the vehicle's battery source and the black clip to the negative or ground terminal. The Power Probe IV start-up tone will sound.

Auxiliary Ground Lead

The auxiliary ground lead provides ground to circuits and components that are not already connected to ground. It also serves as the negative lead for resistance testing. To test the auxiliary ground lead, contact the probe tip and the auxiliary ground lead together. The Green LED should illuminate. This shows that the auxiliary ground lead is working properly. If the green LED does not illuminate, check the replaceable 20 amp fuse in the auxiliary ground lead. The fuse is for protection in the event the ground lead inadvertently contacts the battery positive.

LED Flashlight

Flashlight is a standard feature on the Power Probe IV. The two bright white LEDs are always ON making it possible to see under dashboards and in dark areas.



Mode Navigation

The Power Probe IV has 8 different test modes available:

1. **VDC** – For DC voltage measurements. This is the default mode on startup. Max. 200 VDC
2. **FEED TEST** – For measuring loaded resistance in Ohms and display voltage drop.
3. **AC RMS** – For AC voltage measurements. Displays a True RMS averaged AC voltage. Max 200 VAC.
4. **P-P** – For AC voltage measurements. Displays Peak to Peak AC voltage. Max 200 VAC.
5. **Hz FRQ CTR** – For measuring signal Frequency. Also displays + and - Pulse Width.
6. **FUEL INJ** – Tests Fuel Injectors and Injector circuits.
7. **DRV TST** – Supplies safe voltage for testing computer driver circuits.
8. **PPECT** – Detects the open circuit signal from Power Probe ECT2000 to assist in locating opens.

Refer to sections: *Testing and Measuring Operations* and *Advanced Testing Operations* for further mode descriptions and suggested applications.

To Change Mode



Press
the
"MODE"
button

Scroll up and down
the mode list using
"CLR" for up and
"◀" for down
navigation

Press
the
"MODE"
button again
to select

Testing and Measuring Operations

DC Voltage Measurement in VDC Mode



In this mode, you will supply battery power or battery ground to the tip when pressing the rocker switch



VDC - VDC mode is for testing DC (direct current) voltages. Voltage testing is as easy as contacting the probe tip to a circuit and reading the display. The Power Probe IV will display the probe tip voltage in the center display.

The Power Probe IV automatically enters VDC Mode when first connected to the vehicle's battery, or to a 12-24 volt power supply. VDC Mode is the only mode that the Power Probe IV can supply battery power or ground by pressing the rocker switch.

If the Probe tip voltage is within 0.5 volts of the source battery voltage and the circuit resistance is less than 10 Ohms, the Red LED will illuminate and if the speaker is turned on, the speaker will make a high-tone.

When testing on ground circuits, as long as there is less than 10 Ohms total circuit resistance from tip to battery ground, the Green LED will illuminate and the speaker will make a low-tone.

This greatly simplifies testing as the Power Probe IV's Red/Green LEDs and speaker tones provide a quick indication if there are excessive voltage drops or circuit resistance. If the LEDs do not illuminate and there is no tone from the speaker, you know instantly there may be a circuit problem.

Minimum and Maximum (MIN/MAX) voltages are shown on the bottom of the display. To reset the MIN/MAX, press the left "CLR" button beneath the display.

VDC mode has a very high sampling rate that is good for tests where the tech is looking for glitches or deviations from the main signal. This is a very sensitive mode that can capture even the smallest voltage spikes or drop-outs without having to use a scope.

The Power Probe IV can safely measure up to 200 VDC.

Testing and Measuring Operations Activating Components in VDC Mode

Activating Electrical Components in VDC Mode is one of the main features that make the Power Probe IV very useful when testing. Being able to apply battery power or ground right to the probe tip gives you the ability to activate and dynamically test electrical components such as lights, motors, and solenoids.

You can power up components on the vehicle or on the bench by utilizing the auxiliary ground lead. This type of dynamic component testing is the only true method to verify a components correct operation. Testing a part with a volt-ohmmeter may tell you if the part is out of spec, but you never really know if the part is good until it is operating under power.

Pressing the rocker switch forward supplies battery power to the probe tip.

Pressing the rocker switch rearward supplies battery ground to the probe tip.

The power output is circuit breaker protected. If the component being tested draws too much current, or the circuit has a shorted condition, the Power Probe IV's circuit breaker will trip protecting the tool and the circuit.



When the circuit breaker is tripped, the PPIV display will show "CIRCUIT BREAKER TRIPPED" and will automatically reset itself after a few seconds.

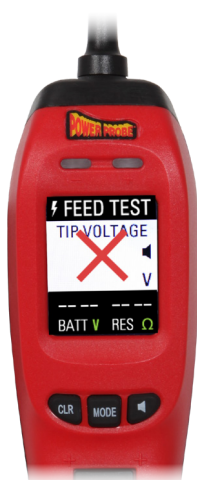

Pressing the rocker switch in any other mode will not apply power or ground and the main screen will display a large red "X".

Testing and Measuring Operations Power Feed Testing



⚡ FEED TEST – Power Feed Test (PFT) is used to check resistance on static circuits or voltage drops on active circuits by simply probing one connection of the circuit being tested.

PFT measures total circuit resistance from the source battery accurately whether there is voltage on the circuit or not, unlike standard multimeters. With the Aux. Ground lead, PFT can also be used like a standard ohmmeter. PFT displays both Battery and Tip voltage simultaneously for easy voltage drop testing.

In this mode, the Power Probe IV display will show:

- ① - Total circuit Resistance on the center screen.
- ② - Probe Tip Voltage.
- ③ - Battery Voltage.

The battery voltage and the tip voltage are both displayed along the bottom of the screen for easy voltage drop testing.

The circuit resistance will be calculated even with voltage applied to the circuit. To accurately test the power and ground feed resistance, the component must be removed from the circuit first. Simply unplug any component, relay, or module on the circuit, contact the probe tip to the circuit and view the circuit resistance.

PFT will display battery voltage (BATT V) from the battery clips in the lower left display area, probe tip (TIP V) voltage in the lower right display area and will provide total circuit resistance readings in the main area of the display all in one test.

Testing and Measuring Operations Power Feed Testing

To test, first disconnect the device or load being operated from the circuit, then contact the probe tip to the circuit being tested. Removing the component from the circuit prevents the component load from affecting and altering the resistance reading.

For voltage drop testing the component must be connected and observe the difference between battery voltage (BATT V) and tip voltage (TIP V)

If the circuit resistance is less than 10 Ohms the Red or Green LED will illuminate and the speaker will make a corresponding tone if the speaker is on. Any differences between battery voltage and tip voltage are easily observed.

PFT can also be used as an ohmmeter on wire or components not connected to battery power or ground. Simply connect the item being tested between the probe tip and the auxiliary ground lead and read the resistance reading in Ohms.

While it is possible to ohm check some components, it should be noted that PFT is primarily for use on wiring only and should never be connected to a solid state component such as a module.

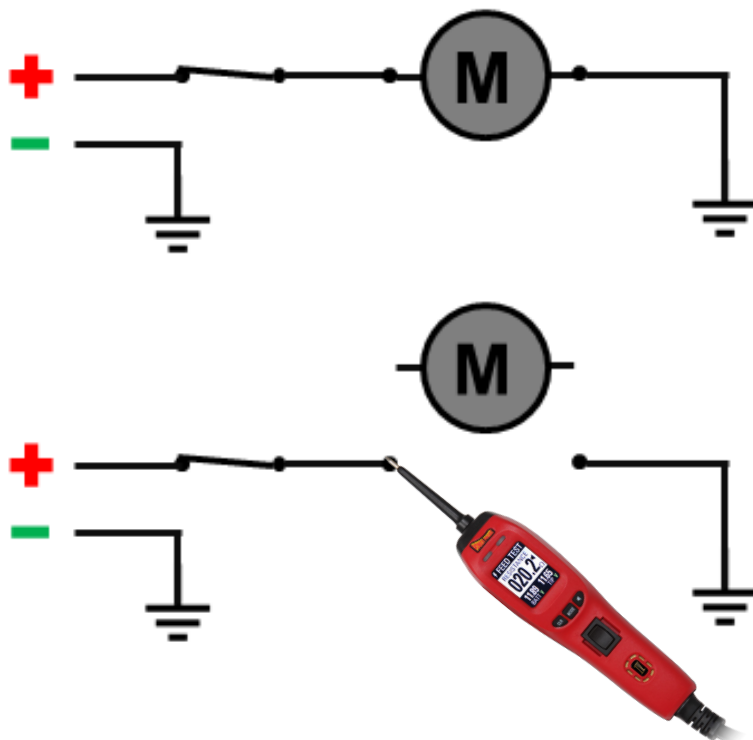

Remove component from circuit before performing Power Feed Test

Power Probe IV

Testing and Measuring Operations AC Voltage Measurement (RMS)



~ **AC RMS** mode is for measuring AC (alternating current) voltages and can be used on any AC voltage or pulsed waveform signal where an RMS averaged voltage measurement is required.

Contact the probe tip to the circuit and it will display an RMS averaged AC voltage reading in the main display area while also displaying RMS Min/Max AC voltages on the bottom line.

Powering up and activating circuits with the rocker switch **can not** be performed in this mode.

Pressing the "CLR" button will reset the Min/Max readings.

AC RMS Voltage is used in the same manner as a standard DVOM would be used to measure the averaged AC voltage in any circuit that produces AC voltage. This can be used for, but not limited to, tests such as checking alternator diode ripple, abs sensors, crank sensors, etc.

The Power Probe IV can safely measure up to **70 VAC**.

WARNING

Do not use the Power Probe IV to test AC line voltage, such as a 120V wall plug. Attempting to use the Power Probe IV on AC line voltage will damage the probe and could cause personal injury.

Testing and Measuring Operations AC Voltage Measurement (P to P)



~ P-P mode can be used on any AC voltage signal where a Peak to Peak (P-P) voltage measurement is required.

P-P stands for Peak to Peak AC voltage. Where AC RMS displays an averaged AC voltage, P-P does not average the reading but displays the total voltage difference from the lowest to highest voltage extreme on an AC signal.

In this mode, the display will be an AC Voltmeter that shows the Tip Voltage in the center and the Min/Max voltage readings along the bottom of the display.

The voltage displayed is the total voltage potential between the lowest and highest voltage sensed on the AC signal being measured.

Powering up and activating circuits with the rocker switch **can not** be performed in this mode.

The total Peak to Peak voltage will be shown in the main display area. The Min voltage will display lowest absolute voltage on the bottom left of the display and the Max voltage will display the highest absolute voltage on the bottom right of the display.

For example, if you have an AC signal that alternates from -50V to +50V the Power Probe IV will display a P-P voltage of 100V, a Min voltage of -50V and a Max voltage of +50V.

Pressing the "CLR" button will reset the Min/Max values.

This can be a more accurate test for signal circuits such as sensors or data communication lines where measuring the full range of the AC signal is required.

The Power Probe IV can measure P-P AC voltage from -100V to +200V or a Maximum RMS AC voltage of 70V.

Testing and Measuring Operations

Frequency Measurement



Hz FRQ CTR – Frequency Counter mode is used for measuring the frequency of an alternating voltage signal.

Contact the probe tip to the circuit and it will display the frequency in Hertz (cycles per second) in the main display area while also displaying the – Pulse Width and + Pulse Width in milliseconds on the bottom line.

The Power Probe IV can measure frequencies from 1Hz to 9999Hz.

FRQ CTR can be used for tests where frequency or pulse width are needed such as MAF sensors, wheel sensors, etc.

Advanced Testing Operations PPECT Mode

(P) PPECT = PPECT Mode is designed to work with the Power Probe ECT2000 for locating open circuit conditions in wiring.

When using the ECT2000 to find opens in wiring, the ECT Transmitter injects a specialized digital signal that is normally picked up by the wireless ECT Receiver. In some situations, such as large wiring bundles or limited access, pinpointing the ECT signal and locating the exact point of the wire failure may be difficult when using the ECT Receiver alone.

When you select the ECT Mode, the Power Probe IV is now specifically tuned to detect the ECT open circuit signal. The Power Probe IV is meant to work by direct contact to the circuit.

Probe and contact the circuit with the ECT signal on it and the main display will show "DETECTED" and the Red/ Green LEDs will illuminate, verifying you are the correct wire. This can greatly aid in detecting opens in tight wire bundles or confined locations.

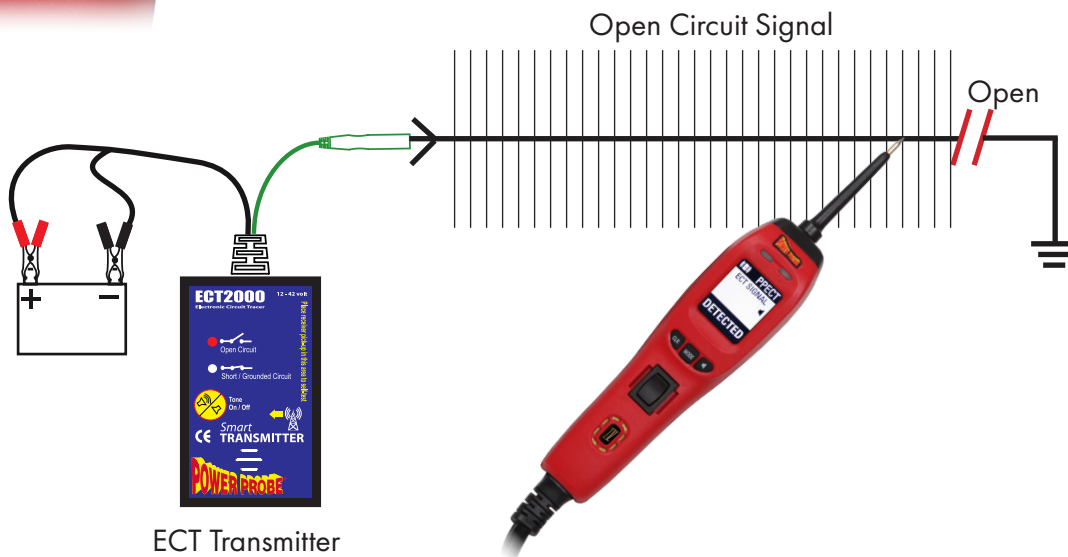

Advanced Testing Operations Fuel Injector Mode

FUEL INJ = Fuel Injector Mode is specifically set-up for fast and easy injector circuit diagnosis. One quick connection to the circuit and the Power Probe IV will display all the needed fuel injector testing information that would normally require using an lab-scope.

Below is an example of a typical fuel injector voltage waveform on a lab scope. This is displaying

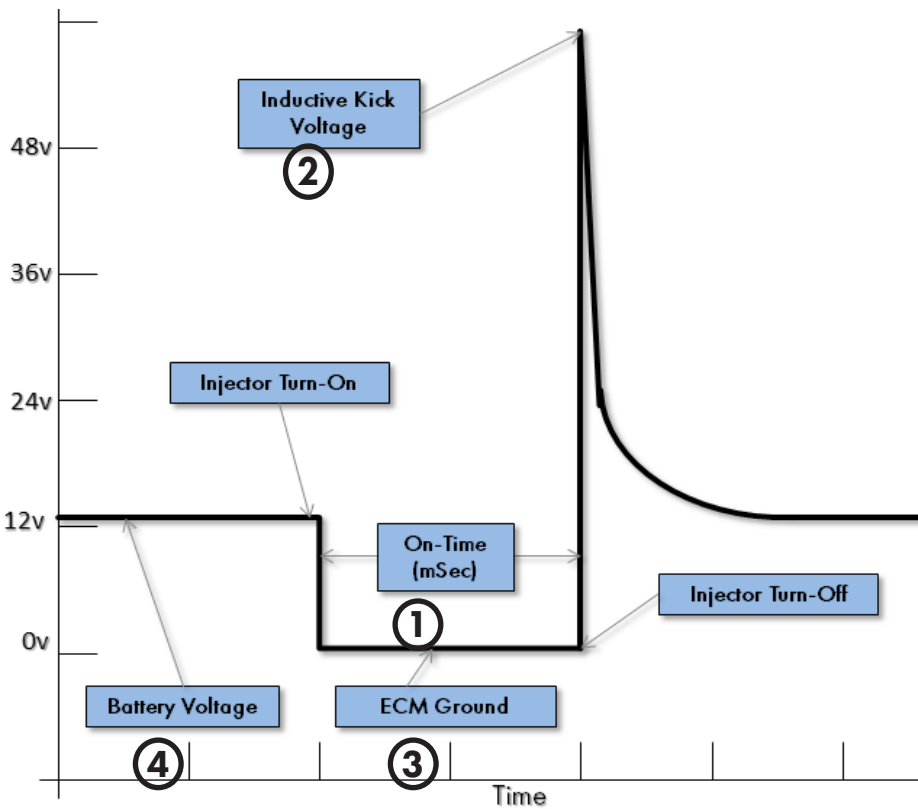

a single injector pulse. The vertical axis represents the circuit voltage and the horizontal axis represents time.

Following the waveform from left to right, you can see the circuit voltage starts near battery voltage until the injector is turned on, this is the **Injector Supply Voltage**.

Then the voltage will drop to near zero when the ECM/PCM switches to ground, or **ECM Ground Voltage**.

The windings inside of a fuel injector produce a magnetic field when the injector is energized. Each time

an injector is turned off, this magnetic field collapses back into the injector windings and induces a hi-voltage spike. This voltage spike is the **Inductive Kick Voltage**.

The time between when the injector is turned on to when the injector is turned off is simply called the **Injector On-Time** and is usually expressed in milliseconds. The Power Probe IV displays each of these four data points on one screen giving a complete picture of the electrical performance of the injector and the entire injector circuit.

The Red/Green LEDs above the LCD display will blink and are synchronized with the injector signal from the ECM with a corresponding tone from the speaker output. These audible and visual cues can quickly identify any intermittent loss of signal from the ECM.

Advanced Testing Operations Fuel Injector Mode

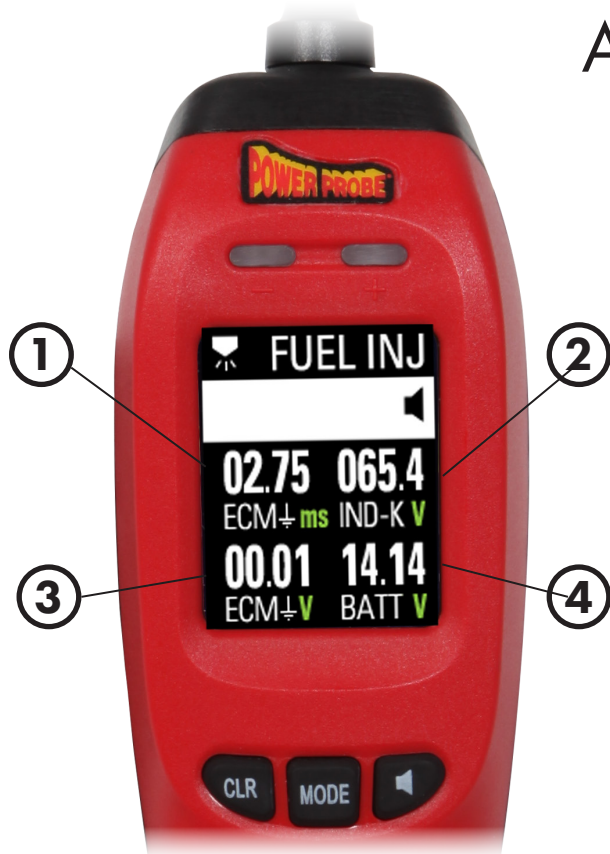

- Select FUEL INJ from the Power Probe IV's test menu.
- Back-probe on the negative side of the injector, either at the injector or at the PCM.
- These four data points represent the corresponding waveform points. (see pg. 15)
- When the engine is running (or cranking) the Power Probe IV's red and green indicator LEDs will blink to indicate a good signal from the ECM/PCM.
- The main screen will display complete injector circuit data for quick comprehensive injector circuit diagnoses.

① **ON ms** = Injector Pulse On-Time (milliseconds) - This is the total amount of time that the fuel injector is energized and supplying fuel to the cylinder. This can be compared to scan tool PID data to see if commanded on-time equals actual on-time

② **IND-K V** = Inductive Kick Voltage - Normal inductive kicks range between 55 and 90 volts. You should see a similar voltage number from each of injectors on the engine. Note: The height of the inductive kick is sometimes cut-off by an internal ECM diode to about 35 to 45 volts. Note: This test does not apply to hi-pressure injectors used on diesel engines and gasoline direct-injection engines.

③ **ECM \perp V** = ECM Ground Voltage - The engine computer activates each fuel injector by completing the ground circuit with an internal transistor switch. When the fuel injector is energized, the ECM ground voltage should be close to zero volts. Actual measured ECM ground voltage can vary, and may be closer to 0.5 volts because of the internal resistance of the switching transistor.

④ **INJ V** = Injector Supply Voltage - This is the battery power being supplied through the fuel injector itself. Measured voltage should be close to full battery voltage. There may be small voltage drops in the circuit, however, anything more than 0.5 volt loss from the source battery voltage should be investigated.

Advanced Testing Operations Driver Testing



 **DRV TST** = Driver Test Mode is design to test the drivers (transistor) inside the module's (PCM, BCM, GEM, etc.) control circuit.

More and more electrical components on modern vehicles are being turned on and off by computer modules or Electronic Control Units (ECUs). Many components, such as transmission solenoids or fuel injectors, can be switched directly from the ECU. Other high current components, like radiator fans are operated thru relays which are then controlled by the ECU. Special transistor circuits, called driver circuits, are built in to these modules that can supply, the current necessary to power these different parts.

Driver circuits' current carrying capabilities are limited and a shorted component that draws more current than it should can overload the driver circuit and cause it to fail.

When testing the control signal to a component, relay or solenoid, the module will need to have the voltage present that the component normally would supply into the module. If the component, relay or solenoid is unplugged the module will no longer be able to pull the voltage to ground

and may not energize the circuit. DRV TST provides a safe voltage supply to validate the circuit or the driver inside the module without the relay or component installed.

Modern ECUs have circuits that let the ECU know if a component is actually plugged in, and the driver circuit will not energize the circuit if no component is there. Also, in order for the computer to detect output faults, like shorts or opens, the component being driven has to be within a specific resistance range or the computer also will not energize the driver circuit. When the Power Probe IV is in Driver Test Mode, it will provide the necessary voltage and pull-up resistance to ensure proper driver testing. (see product specifications pg.19)

Advanced Testing Operations Driver Testing

Driver Testing Explained:

Suppose you had a shorted solenoid that was not working. You know the solenoid will have to be replaced, but you don't yet know if the driver circuit was damaged and you may need to also replace the module. You need a way to safely test the driver circuit without the component connected.

Driver Test Mode will supply a safe, current limited voltage that can be connected directly to the module driver output.

Connect a bi-directional scan tool to the vehicle and command the circuit being tested to an "On" state. You should see the PPIV screen respond if the driver circuit is working.

It is possible to test some driver circuits without a bi-directional scan tool, however, you will have to know what running conditions will make the circuit you are testing switch to an "On" state and then re-create those conditions to energize the circuit.



Tool Repair Operations Rocker Switch Replacement

The Power Probe IV Rocker Switch is used constantly and arcing can occur across the switch contacts and eventually the switch can wear out.

The Power Probe IV also has an Automatic Resetting 8Amp Thermal Circuit Breaker and like the Rocker Switch, the Circuit Breaker can also wear out over time. If this occurs, the Rocker Switch and the Circuit Breaker are made to be easily field replaceable.

Replacement Rocker Switches (Part # PN005) and Circuit Breakers (Part # 30-00041) can be purchased from your tool dealer or from Power Probe direct at www.powerprobe.com/webstore/

Follow the instructions below to replace a worn Rocker Switch -



Locate the two slots on either side of the Rocker Switch.



Carefully remove the Rocker Switch with an appropriate pry tool or small screwdriver. Do not apply excessive force.



Position the new Rocker Switch into the switch cavity and carefully press straight down until the switch is flush with the housing.

Tool Repair Operations Circuit Breaker Replacement

Follow the instructions below to replace a worn Circuit Breaker -



Unscrew the two retaining screws and remove the rear cover.



Using an appropriate pry tool or small screwdriver, carefully pry the Circuit Breaker towards the tip to dis-engage it from the breaker terminals. Do not apply excessive force.



Once the Circuit Breaker is loose from the terminals, carefully lift the breaker from the housing cavity.



Position the new Circuit Breaker into the housing, take care to line up the breaker spades with the breaker terminals, and press down gently until the Circuit Breaker is fully engaged into the breaker terminals.

Replace the rear cover and the two retaining screws.

Specs

Product Specifications

| | |
|--------------------------------------|---|
| Min Operating Voltage | 8 VDC |
| Max Operating Voltage | 30 VDC |
| Max Tip Voltage | 450 Volts |
| Probe Tip Resistance to Ground | 130K Ohms |
| Computer Safe | 0.1 mA floating tip |
| Voltage Measurement | -100 to 200 VDC / VAC (70 VAC RMS) |
| Voltage Resolution | -99.99 to 99.9 V – 0.01V (10mV) 100.0 to 199.9 V – 0.1V (100mV) |
| Glitch Capture | >380µS Min Pulse Width |
| Power Feed Test | < 30 mA |
| Resistance Measurement | 0.1 Ohms to 10K Ohms |
| Frequency Measurement | 1Hz to 9999Hz |
| Driver Test | 50 Ohm Pull Up on Tip Driver On Range: 50mV to 1V |
| ECT Signal Detection | 2 sec. |
| Fuel Injector Mode | LED Flash @ Min 35V @ 100µS Pulse |
| Red LED Response | Within 0.5V BATT V and < 10 Ohms |
| Green LED Response | < 10 Ohms |
| Circuit Breaker | 8 Amp Thermal – Auto Reset |
| Breaker Trip Response | 8 Amps = No Trip 10 Amps = 20 min. 15 Amps = 6 sec. 25 Amps = 2 sec. Short Circuit = 0.3 sec. |
| Operating Temperature | -20°C (-4°F) to 50°C (122°F) |
| Storage Temperature | -40°C (-40°F) to 65°C (149°F) |

Notes

.....
.....
.....
.....
.....

.....
.....
.....
.....
.....
.....
.....
.....
.....

Warranty

Power Probe Warranty

Power Probe Products undergo a strict quality control inspection for workmanship, function, and safety before leaving the factory. From the date of purchase, we will warranty/repair Power Probe products for one (1) year against defects in parts and workmanship. All repair due to misuse will be charged a fee not to exceed the cost of the tool. All warranty units must be accompanied by a copy of the original sales receipt. In the event of a malfunction or defective unit, please contact your Power Probe dealer.

For the latest product information and updated manuals go to www.powerprobe.com

Power Probe, Inc.
760 Challenger St.
Brea, California 92821
toll free 800.655.3585
local 714.990.9443
fax 714.990.9478

DOC# 300-00010 REV 00

POWER PROBE[®]

The Next Generation of Diagnostics

www.powerprobe.com · 800-655-3585